

# ARIZE™ ELEMENT

# L1000

Enabling efficient growth at an industrial scale

With a 232% increase in PPF levels compared to the previous generation, the Arize™ Element L1000 is a true one-to-one high pressure sodium lamp replacement for greenhouse and indoor applications.

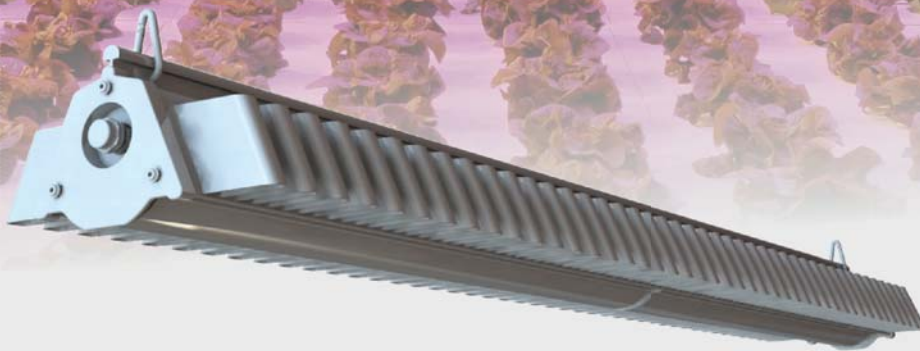

## ■ Efficient

Energy efficiency surpassing  $3.5 \mu\text{mol}/\text{J}$  makes the L1000 the most efficient grow light in its class

## ■ Flexible

Multiple installation options mean the L1000 can be installed on virtually any structure in seconds

## ■ Powerful

Produces the same light output as a 1000W HPS luminaire using only 40% of the energy

## Installation Options

Suitable for standard 'Unistrut' fixing of 41mm cross section where there is no risk of vibration or accidental collision by equipment onto the luminaire

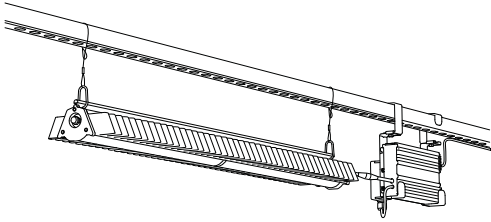

### ■ Side-by-side

The standard option, with 200mm support wires and 41mm square brackets pre-installed on the power supply

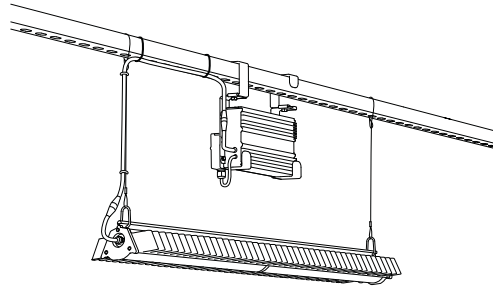

### ■ Over-under

600mm, 1500mm or 3000mm support wires reduce the distance from the luminaire to the crop, for more intense, focused lighting

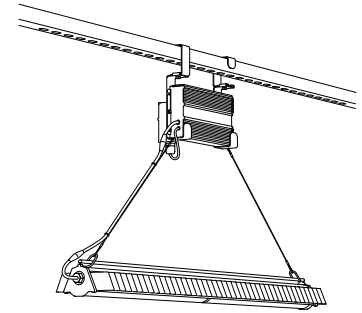

### ■ Triangular

Pre-drilled holes in the Driver brackets allow the L1000 to be suspended from the Driver

### ■ Driver

Other Mounting accessories for Driver installation and Junction Box to be ordered separately

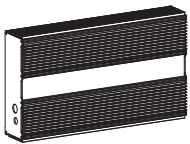

### ■ Driver Mounting Accessories

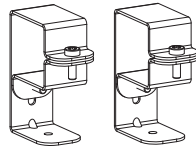

GEHAK-LN-NN-N0

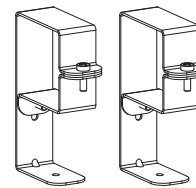

GEHAK-NN-NN-N0

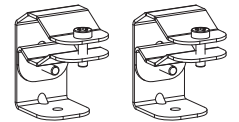

GEHAK-MN-NN-N0

## Mechanical Outline

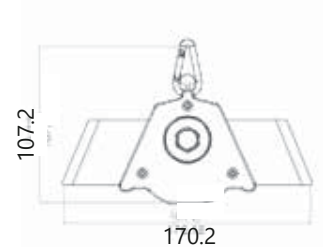
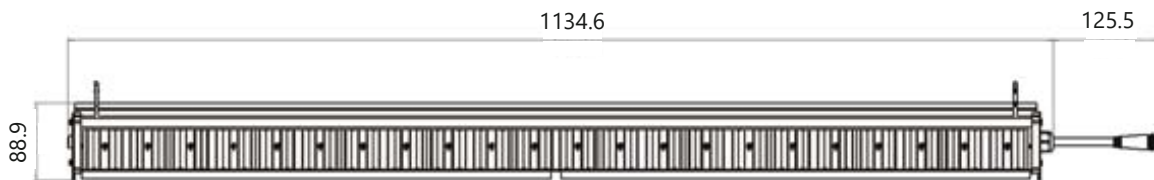

### Dimensions and Weight

	Length	Width	Height	Weight
L1000 Luminaire	1134.6 mm	170.2 mm	88.9 mm	3.5 kg
Driver	274.5 mm	143.26 mm	48.5 mm	3.5 kg



## Colour Spectrum

### Type R 6:1 (R:B)

Increased electrical and photosynthetic efficiency through increased red light

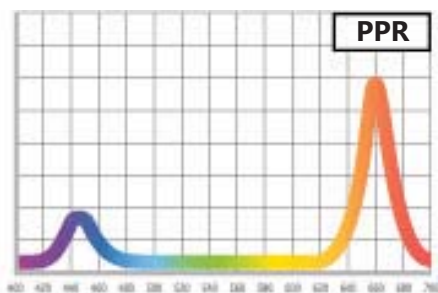

### Type B 3:1 (R:B)

Our balanced spectrum encourage secondary plant metabolite production

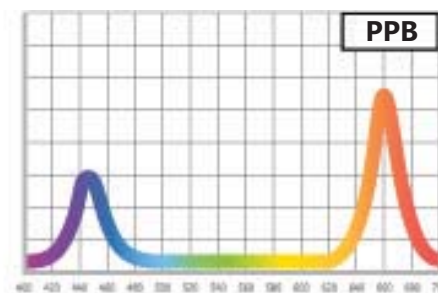

Our purple spectrum (PP-) maximize efficiency while providing crops with everything they need, lowering your energy costs while maximizing your output

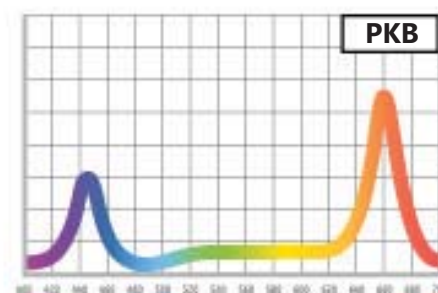
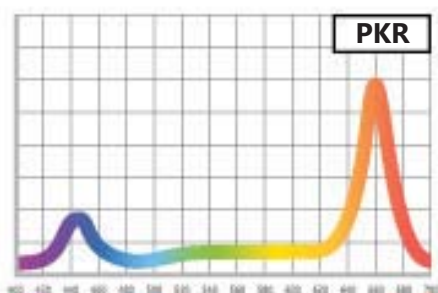

Our broad spectrum offerings (PK-) are tailored to suit multiple stages of plant growth, from propagation to cultivation, while providing a beautiful environment for work and research

## Accessories

Order code	Description	Components
GEHAK-NN-FB-N0	L1000 600mm suspension kit	600mm support wire + 900mm extension cable
GEHAK-NN-CC-N0	L1000 1500mm suspension kit	1500mm support wire + 1800mm extension cable
GEHAK-NN-DD-N0	L1000 3000mm suspension kit	3000mm support wire + 3600mm extension cable
GEHAK-LN-NN-N0	50mm x 50mm driver bracket kit	2x 50mm square bracket + screws + nuts
GEHAK-NN-NN-N0	75mm x 75mm driver bracket kit	2x 75mm square bracket + screws + nuts
GEHAK-MN-NN-N0	Ø20mm-30mm driver bracket kit	2x Ø20mm-30mm bracket + screws + nuts
GEHAK-NN-NE-N0	Driver 3000mm non standard installation kit	3000mm loop to toggle support wire
GEHAK-NN-NN-E1	Junction Box	Junction Box

## Order Logic Table

Product Family	Output	Colour Spectrum	Nominal Length	Input Voltage	Beam Angle	Control	Gen
<b>GEHTL</b>	<b>E</b> = High Efficacy <b>M</b> = Medium <b>H</b> = High	<b>PPR</b> = Purple Reproductive <b>PPB</b> = Purple Balance	<b>4</b> = 4ft	<b>6</b> = 220-240V* <b>7</b> = 220-240V** <b>8</b> = 380-415V**	<b>N</b> = 120°	<b>X</b> = None	<b>1</b>

\* Only available with 200W

\*\* Only available with 320W and 600W

## Specification Table

Order Logic	Description	PPF (μmol/s)	Power (W)	Efficiency (μmol/J)	HPS Equivalent (W)
GEHTL-EPPR4-6NX1	Purple Reproductive, 200W, 220-240VAC	623	178	3.5	400
GEHTL-EPPB4-6NX1	Purple Balance, 200W, 220-240VAC	612	180	3.4	400
GEHTL-MPPR4-7NX1	Purple Reproductive, 320W, 220-240VAC	1038	310	3.3	600
GEHTL-MPPB4-7NX1	Purple Balance, 320W, 220-240VAC	1013	314	3.2	600
GEHTL-MPPR4-8NX1	Purple Reproductive, 320W, 380-415VAC	1038	310	3.3	600
GEHTL-MPPB4-8NX1	Purple Balance, 320W, 380-415VAC	1013	314	3.2	600
GEHTL-HPPR4-7NX1	Purple Reproductive, 600W, 220-240VAC	1827	599	3.1	1000
GEHTL-HPPB4-7NX1	Purple Balance, 600W, 220-240VAC	1761	601	2.9	1000
GEHTL-HPPR4-8NX1	Purple Reproductive, 600W, 380-415VAC	1827	599	3.1	1000
GEHTL-HPPB4-8NX1	Purple Balance, 600W, 380-415VAC	1761	601	2.9	1000

## Technical Parameters

Dimming	0-10V	Operating Environment	0°C to 50°C
Power Factor	>0.9	IP Rating	IP66
Max. Distance Luminaire to Driver	3600mm	Lifetime	L90: >36,000 hours
Cooling	Passive	Warranty	Five-year System Warranty
Light Distribution	120°	System Certifications	CE